



# **Compton USD Learning Packet #6**

**Tenth Grade**

# 10th Grade Learning Packet

## TABLE OF CONTENTS

### Week 7

Day	Lesson	Date Completed
<b>1</b>	1) Grammar Worksheet #1	
	2) HMH Math- 16.3 Reteach Parts of Similar Figures	
	3) HSS - Read, "The Paris Peace Conference and Treaty of Versailles of 1919"	
	4) ELD-Pre-reading-Cornell Notes (The Necklace-short story)	
<b>2</b>	1) Grammar Worksheet #2	
	2) HMH Math-16.3 Practice & Problem Solving: <i>Modified</i>	
	3) HSS - Read and Annotate section, "Complicated Negotiations"	
<b>3</b>	1) Grammar Worksheet #3	
	2) HMH Math-16.3 Practice & Problem Solving: A/B	
	3) HSS - Read and Annotate section, "Promise That All Powers Would Disarm Equally"	
	4) ELD-During Reading: Read the short story The Necklace and annotate the text.	
<b>4</b>	1) Grammar Worksheet #4	
	2) HMH Math 16.3 Practice & Problem Solving: C	
	3) Read and Annotate section, "War Criminals, Death Sentence and Paving the Way for Hitler"	
<b>5</b>	1) Grammar Worksheet #5	
	2) HMH Math-16.3 Reading Strategies: Use a Venn Diagram	
	3) HSS - Complete: 1) Flow Map of Effects and 2) Take Quiz, #1-4	
	4) ELD-Plot Structure-Text Diagram Elements (After Reading)	

Name \_\_\_\_\_ Date \_\_\_\_\_

## 1 NOUNS

**A noun is the part of speech that names a person, a place, a thing, or an idea.**

There are different types of nouns. See the examples below.

<b>Common noun</b>	class of person, place, or thing	girl, city, month
<b>Proper noun</b>	specific person, place, or thing	Maria, Dallas, December
<b>Concrete noun</b>	something you can see, touch, taste, hear, or smell	table, hat, pen
<b>Abstract noun</b>	something you can't perceive through your senses	loyalty, hope, freedom

### Practice A Identifying Nouns

Read each sentence. Then, underline the nouns in each sentence.

**Example:** Our decision was to eat dinner before the movie.

**Answer:** Our decision was to eat dinner before the movie.

- The present is on the table.
- Please take Sally to the dentist.
- My brother slept through the movie.
- Call the office after the package arrives.
- The weather in Chicago is cold in January.
- The firefighter received a medal for her bravery.
- Her family moved to the United States from China.
- Gymnastics requires balance and strength.
- Our choir visited the White House in Washington, D.C.
- The friendship between Rich and Tom has lasted for years.

### Practice B Labeling Nouns

Read each sentence. Then, on the line provided, identify whether each underlined noun is (1) common or proper and (2) concrete or abstract.

**Example:** Did you give your pencil to Paul?

**Answer:** pencil—common, concrete; Paul—proper, concrete

- Your friendship is important to me. \_\_\_\_\_
- Aunt Mary visited my family yesterday. \_\_\_\_\_
- Please pass the potatoes. \_\_\_\_\_
- My uncle lives in Florida. \_\_\_\_\_
- A puppy needs a lot of attention. \_\_\_\_\_
- Can I use the telephone to call Grandpa? \_\_\_\_\_
- Our deepest hope is for freedom. \_\_\_\_\_
- Have you read Tom Sawyer by Mark Twain? \_\_\_\_\_
- My frustration grew over time. \_\_\_\_\_
- No other bridge is as beautiful as the Brooklyn Bridge. \_\_\_\_\_

### Writing and Speaking Application

Write a two-sentence description of your classroom, using at least six nouns. Circle the nouns. Then, take turns reading your sentences with a partner. Your partner should listen for and name the nouns in your sentences. Then, switch roles with your partner.

## Writing: News Story

### Practice

A **news story** presents facts about events that have occurred. News stories answer the questions *Who? What? When? Where? Why?* and *How?* The opening sentence or paragraph of a news story should make the reader want to read more.

**A** Read the news story. Then, complete the following activities.

Early Tuesday morning, the Carpenter family was saved from a possible tragedy by their family dog, Tommy. A spark from the fireplace had landed unnoticed on the carpet. After the family went to bed, the spark started a fire. The alert Tommy woke the family by barking and scratching at the bedroom doors. The Carpenters escaped and called firefighters, who quickly put out the fire. The family was safe, and their home suffered very little fire damage, thanks to Tommy. Mr. Carpenter said that Tommy has been a member of the family for nearly ten years and that he had always been protective of family members.

Write the answers to each of the following questions using the news story:

Who? \_\_\_\_\_

What? \_\_\_\_\_

When? \_\_\_\_\_

Where? \_\_\_\_\_

Why? \_\_\_\_\_

How? \_\_\_\_\_

**B** Explain how the first sentence makes the reader want to read more.

---

---

---

---

**LESSON**  
**16-3**

# Corresponding Parts of Similar Figures

## Reteach

Similar figures have certain characteristics:

- The corresponding angles are congruent.
- The corresponding sides are in proportion.

The two triangles shown are similar.

$$\triangle PQR \sim \triangle UVW$$

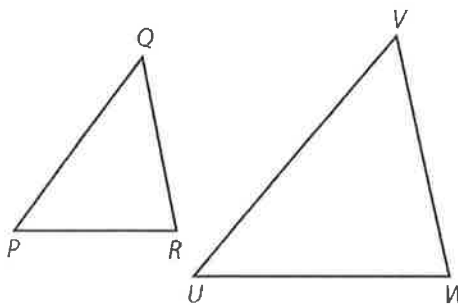

Therefore, the following is true:

$$\angle P \cong \angle U \quad \angle Q \cong \angle V \quad \angle R \cong \angle W$$

$$\frac{PQ}{UV} = \frac{QR}{VW} = \frac{PR}{UW}$$

Trapezoid  $ABCD$  is similar to trapezoid  $EFGH$ .  
Complete the following statements.

1.  $\angle B \cong \angle$  \_\_\_\_\_

2.  $\frac{AB}{HG} = \frac{CB}{FG} = \frac{AD}{EH} = \frac{DC}{GH}$

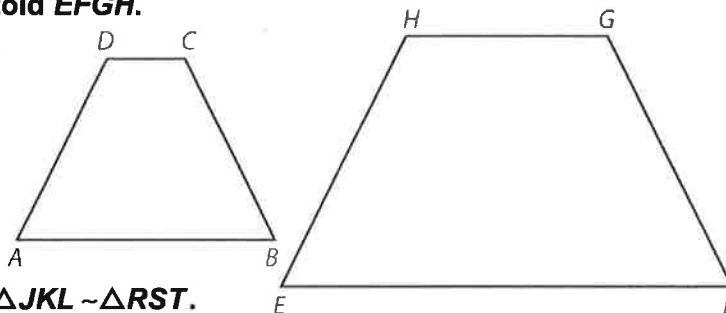

Find the missing measurements if  $\triangle JKL \sim \triangle RST$ .

3.  $m\angle J =$  \_\_\_\_\_

4.  $ST =$  \_\_\_\_\_

5.  $JL =$  \_\_\_\_\_

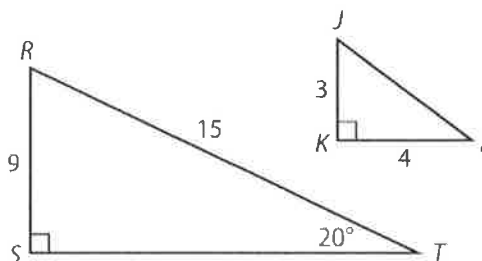



Name \_\_\_\_\_ Date \_\_\_\_\_

## 2 PRONOUNS

**Pronouns are words that stand for nouns or for words that take the place of nouns.**

Pronouns get their meaning from the words they stand for. These words are called *antecedents*. Reciprocal pronouns *each other* and *one another* refer to a plural antecedent. They express a mutual action or relationship.

Show that you can use and understand the function of pronouns by completing the following exercises.

### Practice A Identifying Antecedents

Read each sentence below. Then, draw an arrow that points from the underlined pronoun to its antecedent.

**Example:** Michael loves his school.

**Answer:** Michael loves his school.

- Mary did the job herself.
- Jamal works hard at his job.
- Successful students do their homework.
- Rachel took her daughter to the park.
- Andrew likes work. He spends a lot of time there.
- Roderick wrote his mom a letter.
- If Jessie does the chores, she will get an allowance.
- Dennis is very kind to his employees.
- When Kate exercises, she feels better.
- If Cameron does the work, he will succeed.

### Practice B Identifying Reciprocal Pronouns

Read each sentence below and underline the reciprocal pronouns.

**Example:** They always help each other.

**Answer:** They always help each other.

- At Christmas, we give each other gifts.
- Good people are kind to one another.
- The men shook hands with each other.
- It is obvious that they are fond of one another.
- The children cooperate with one another.

### Writing and Speaking Application

Write five sentences that include pronouns. Circle the pronouns and draw an arrow to their antecedents. Read your sentences to a partner, who will identify the pronouns and their antecedents. Then, switch roles with your partner.

Name \_\_\_\_\_ Date \_\_\_\_\_

# Writing: News Story

## Assess

**A** Think of a recent event that has occurred in your school or community. Based on the event, write an answer to each of the following questions.

Who? \_\_\_\_\_

What? \_\_\_\_\_

When? \_\_\_\_\_

Where? \_\_\_\_\_

Why? \_\_\_\_\_

How? \_\_\_\_\_

**B** Use your answers to the questions in Exercise A to write a news story about the event. Include an opening sentence that makes the reader want to continue reading the story.

\_\_\_\_\_

\_\_\_\_\_

\_\_\_\_\_

\_\_\_\_\_

\_\_\_\_\_

\_\_\_\_\_

\_\_\_\_\_

\_\_\_\_\_

\_\_\_\_\_

\_\_\_\_\_

\_\_\_\_\_

\_\_\_\_\_

\_\_\_\_\_

\_\_\_\_\_

\_\_\_\_\_

\_\_\_\_\_

\_\_\_\_\_

\_\_\_\_\_

\_\_\_\_\_

\_\_\_\_\_

\_\_\_\_\_



**LESSON**  
**16-3**

**Corresponding Parts of Similar Figures**

*Practice and Problem Solving: Modified*

Fill in the blanks to complete each postulate or theorem. The first one is done for you.

1. If the three sides of one triangle are proportional to the three sides of another triangle, then the triangles are similar.
2. If two sides of one triangle are proportional to two sides of another triangle and their included angles are congruent, then the triangles are \_\_\_\_\_.
3. If two angles of one triangle are \_\_\_\_\_ to two angles of another triangle, then the triangles are similar.

Fill in the blanks to complete the statements about similar figures. The first one is done for you.

4. Triangles  $CDE$  and  $FGH$  are similar. Write three statements about their angle measures.

$m\angle C = m\angle F$   $m\angle D =$  \_\_\_\_\_  $m\angle E =$  \_\_\_\_\_

5. Complete the proportions relating the side lengths of triangles  $CDE$  and  $FGH$ .

$\frac{CD}{FG} = \frac{CE}{GH}$   $\frac{DE}{FH} = \frac{CD}{CE} = \frac{DE}{FH}$

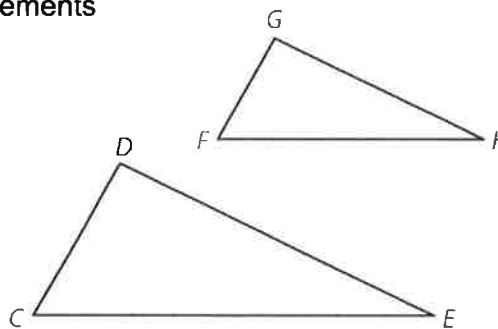

6. All \_\_\_\_\_ triangles are similar.

For Problems 7–10, two similar figures are named. Answer the questions based on the information provided. (If it helps you, draw sketches of the figures on separate paper.) The first one is done for you.

7.  $ABCD \sim EFGH$ . Both figures are rectangles.

$\frac{BC}{FG} = 3$ . Side  $\overline{EF}$  measures 5 inches. What is the length of  $\overline{AB}$ ? 15



8.  $\triangle HIJ \sim \triangle KLM$ . Angles  $J$  and  $M$  are right angles.

$m\angle H = 60^\circ$ . What is the measure of  $\angle L$ ? \_\_\_\_\_

9.  $\triangle PQR \sim \triangle STU$ .  $PQ = 7$ .  $ST = 28$ .  $PR = 6$ . What is  $SU$ ? \_\_\_\_\_

10.  $\triangle VWJ \sim \triangle YZX$ . Knowing the measures given in the figure, what is  $YZ$ ? \_\_\_\_\_

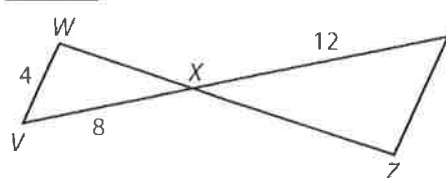



Name \_\_\_\_\_ Date \_\_\_\_\_

### 3 ACTION VERBS AND LINKING VERBS

**A verb is a word or group of words that expresses time while showing an action, a condition, or the fact that something exists.**

There are different types of verbs. See the examples below.

<b>Action verb</b>	tells what action someone or something is performing	go: is going, went run: is running, ran fly: is flying, flew learn: is learning, learned
<b>Linking verb</b>	connects its subject with a noun, a pronoun, or an adjective that identifies or describes the subject	be: is, am, was, were, could be, would be, has been feel: is feeling, felt become: is becoming, became

#### Practice A Identifying Action Verbs

Read each sentence. Underline the action verb.

**Example:** Susan ran around the track.

**Answer:** Susan ran around the track.

1. Tyrell plays the guitar.
2. Robert works at the factory.
3. Sarah drank the juice.
4. Connie helps a lot of people.
5. Albin cooks delicious food.
6. Heidi swam to shore.

#### Practice B Identifying Linking Verbs

Read each sentence. Underline the linking verb.

**Example:** Cathy feels sick.

**Answer:** Cathy feels sick.

1. Richard is a soldier.
2. Tamara's voice sounds wonderful.
3. Her son became a doctor.
4. He felt better after we talked.
5. Jason appeared upset.

#### Practice C Distinguishing Between Action Verbs and Linking Verbs

Underline the verbs in the following sentences. Then, write whether the verb is an action verb or a linking verb.

**Example:** He flies jets for a living.

**Answer:** He flies jets for a living. action verb

1. After dinner, she became sick. \_\_\_\_\_
2. We played the best game ever! \_\_\_\_\_
3. Ashley was so happy about the puppy. \_\_\_\_\_
4. Jared is my best friend. \_\_\_\_\_
5. The children argued about television shows. \_\_\_\_\_

#### Writing and Speaking Application

Write five sentences, some that use an action verb and some that use a linking verb. Read the sentences to a partner. Your partner should listen for and name the verb and tell whether it is an action verb or a linking verb. Then, switch roles with your partner.

## Writing: Short Story

### Practice

A **short story** is a brief, fictional narrative composed of plot, setting, and characters. It is told from a consistent first-person or third-person point of view. It follows a chronological time order, and often includes dialogue.

**A** Read the following passages. Then, write your answer to each question.

1. I entered the room quietly, hoping that I would not wake the sleeping dog.

What is the point of view in this passage? \_\_\_\_\_

2. Angela slid into her desk before the bell rang. This was the first day at her new school. She was a year younger than her classmates, most of whom were 15. That made her feel even more shy. Her shyness made her blush as other students filed past her desk, looking at her. She stared down at her desktop, her long blond hair falling forward over her face.

**A.** Write some key details about the character in this passage.

\_\_\_\_\_

**B.** What is the conflict or problem faced by the character in this passage?

\_\_\_\_\_

3. I knew that somehow the time machine had gone out of control. I found myself in a dense forest of strange plants that appeared to be huge ferns. Little light penetrated the forest, and a thick fog covered the ground. Suddenly I felt the ground begin to tremble. At the same time, I heard an ear-splitting roar very near. It was the roar of an animal—a *very large* animal.

Write the details of the setting described in this passage.

\_\_\_\_\_

\_\_\_\_\_

**B** Choose one of the passages in Exercise A. Add one or more characters to the story. Then, create a brief dialogue between the characters. Make sure the dialogue is related to the story and adds to the action.

\_\_\_\_\_

\_\_\_\_\_

**LESSON**  
**16-3**

# Corresponding Parts of Similar Figures

## Practice and Problem Solving: A/B

For Problems 1–3, apply properties of similar figures.

1. Devon says that triangles  $TUV$  and  $XYZ$  are similar because  $\frac{TU}{XY} = \frac{UV}{YZ} = \frac{XZ}{TV}$ . What is wrong with his reasoning?

\_\_\_\_\_

2. Triangles  $CDE$  and  $FGH$  are similar. Write three proportions relating the triangles' side lengths, and three statements about their angle measures.

\_\_\_\_\_

3. Are all rhombuses similar? Explain your answer.

\_\_\_\_\_

Use the diagram for Problems 4 and 5.

4. In the diagram of the tandem bike,  $\overline{AE} \parallel \overline{BD}$ . Explain why  $\triangle CBD \sim \triangle CAE$ .

\_\_\_\_\_

5. Find  $CE$  to the nearest tenth. Show your work.

\_\_\_\_\_

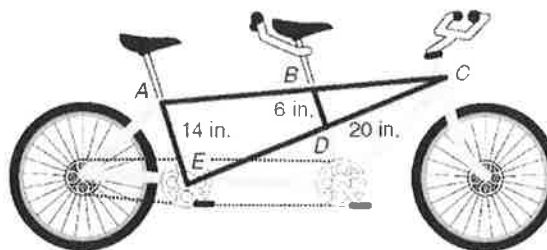

For Problems 6 and 7, show that the figures are similar by using a ruler to find the center of dilation. Name the center point.

6. (\_\_\_\_, \_\_\_\_)

7. (\_\_\_\_, \_\_\_\_)

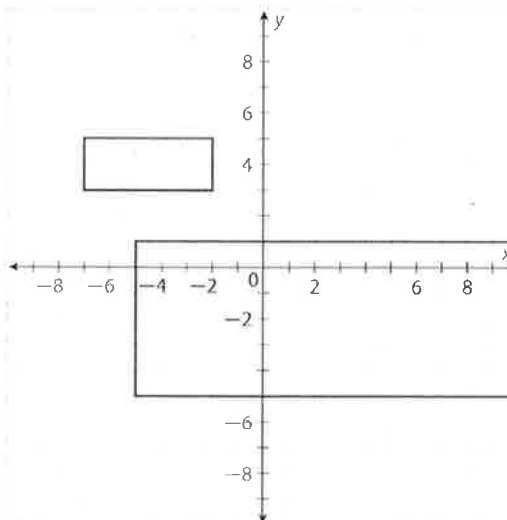
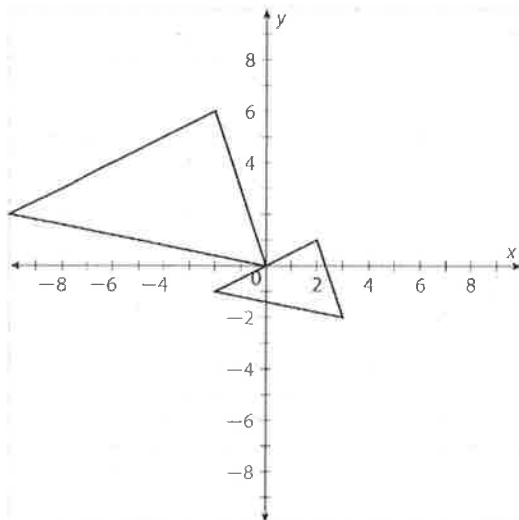



Name \_\_\_\_\_ Date \_\_\_\_\_

**4 TRANSITIVE AND INTRANSITIVE VERBS****A transitive verb directs action toward someone or something named in the sentence.****An intransitive verb does not direct action toward anyone or anything named in the sentence.**

The word that receives the action of a transitive verb is called the object of the verb. You can determine whether a verb has an object by asking *whom* or *what* after the verb.

Transitive: The boy lost his jacket. (Lost what? his jacket)

Intransitive: The baby cried loudly. (Cried what? [no answer])

**Practice A Identifying Transitive Verbs and Their Objects**

Read each sentence. Then, underline the verb and circle the object of the verb.

**Example:** Mom baked a delicious cake.

**Answer:** Mom baked a delicious cake.

1. Tim sold hot chocolate at the game.
2. Kelly wore glasses.
3. Mom and Dad ate all of the pie.
4. The kitten scratched my hand.
5. I pictured success in my mind.
6. Chris took the garbage to the curb.
7. Michael forgot his backpack.
8. Belle asked several questions.
9. The dog ate the leftovers.
10. The doctor washed his hands.

**Practice B Distinguishing Between Transitive Verbs and Intransitive Verbs**

Read each sentence. Then, write the action verb and label it transitive or intransitive.

**Example:** The baby cried for her bottle.

**Answer:** cried—intransitive

1. Miette walked to the store. \_\_\_\_\_
2. James did his homework. \_\_\_\_\_
3. Ethan played his guitar all morning. \_\_\_\_\_
4. The grass grew quickly. \_\_\_\_\_
5. The plane holds over a hundred people. \_\_\_\_\_
6. Chloe sprained her ankle. \_\_\_\_\_
7. Benjamin runs faster than anybody else. \_\_\_\_\_
8. Mr. Young wants a new dog. \_\_\_\_\_
9. Steve forgot the party. \_\_\_\_\_
10. His mom washed the dishes. \_\_\_\_\_

**Writing and Speaking Application**

Write four sentences, two with transitive verbs and two with intransitive verbs. Read your sentences to a partner. Your partner should listen for each verb and name it *transitive* or *intransitive*. Then, switch roles with your partner.

## Writing: Short Story

### Assess

Choose one of these topics to create a short story. Then, complete the activities.

the case of the missing soccer ball

two friends compete for a place on the team

why Mary Ann wanted to dance

a scientist discovers a strange new animal

1. Briefly summarize your idea for a story.

---

---

2. Identify your audience and keep it in mind as you write. \_\_\_\_\_

3. Identify the point of view you will use. \_\_\_\_\_

4. List the characters you will include in your story. \_\_\_\_\_

---

5. Write the key details about each character: name, age, appearance, and personality traits.

---

---

6. Write some details of the setting, including time and place.

---

7. Decide on a conflict or problem and state it in one or two sentences.

---

---

8. Create dialogue that uses words that suit each personality and moves the action of the story forward. Tell where in the plot you will use the dialogue.

---

---



**LESSON**  
**16-3**

**Corresponding Parts of Similar Figures**

**Practice and Problem Solving: C**

Use principles of similarity to solve Problems 1–4.

1. Triangles  $CDE$  and  $FGH$  are similar. Write six different proportions relating the side lengths of the triangles, and three statements about their angle measures.
2. Study the proportions you wrote for Problem 1. Pick out two different proportions that relate the same four side lengths. Using  $w$ ,  $x$ ,  $y$ , and  $z$  to stand for the four side lengths, write algebraic equations to show why the two proportions are equivalent. Explain your reasoning.

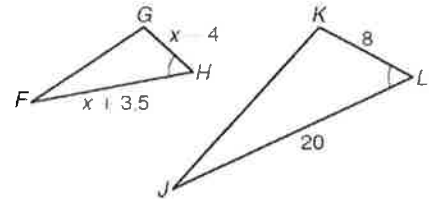

3. Find the value of  $x$  that makes  $\triangle FGH \sim \triangle JKL$ .

\_\_\_\_\_

4. Is  $\triangle WXZ \sim \triangle XYZ$ ? Explain.

\_\_\_\_\_

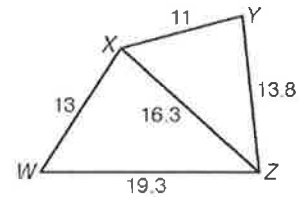

Use the figure to the right for Problems 5–8.

5. Identify the three similar triangles in the figure. Be sure to name the vertices in the correct order.

$\triangle ABC \sim \triangle \underline{\hspace{1cm}} \sim \triangle \underline{\hspace{1cm}}$

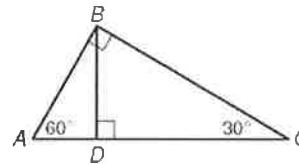

6. Write the ratios for the corresponding sides of each pair of similar triangles. (Note: The hypotenuse of a 30-60-90 triangle is twice as long as the shorter leg.)

\_\_\_\_\_

7.  $AD = 1$  and  $DC = 3$ . Find the perimeter of  $\triangle ABC$ . \_\_\_\_\_

8. Using the ratios you found in Problem 6 and the answer to Problem 7, find the perimeters of  $\triangle ADB$  and  $\triangle BDC$ . perimeter of

$\triangle ADB$ : \_\_\_\_\_ perimeter of  $\triangle BDC$ : \_\_\_\_\_



Name \_\_\_\_\_ Date \_\_\_\_\_

## 5 VERB PHRASES

**A verb phrase consists of a main verb and one or more helping verbs.**

One or more helping verbs may precede the main verb in a verb phrase. For example, in the sentence, "I will be arriving at school on time," *will* and *be* are helping verbs, and *arriving* is the main verb. Common helping verbs are shown in the table below.

be	do	have	shall	can
is	does	has	should	could
was	did	had	will	may
were			would	might
(all forms of be)				must

### Practice A Recognizing Verb Phrases

Read each sentence. Then, write the verb phrase on the line provided.

**Example:** I will be taking science first period.

**Answer:** will be taking

- |   |   |
|---|---|
| 1. You should have finished the paper before watching TV. _____ | 6. I have seen this movie four times. _____           |
| 2. My family is leaving next week. _____                        | 7. Nicole will be working tomorrow. _____             |
| 3. Truong is painting his house. _____                          | 8. Chad has been posting updates from his trip. _____ |
| 4. My dog was not expecting two shots today. _____              | 9. Cathy is raising five kids. _____                  |
| 5. That car does use a lot of gas. _____                        | 10. He is planning a trip to Japan. _____             |

### Practice B Identifying Helping Verbs and Main Verbs

Read each sentence. Then, underline the helping verbs and circle the main verbs.

**Example:** She is using her mom's computer.

**Answer:** She is (using) her mom's computer.

- |   |   |
|---|---|
| 1. They are adopting a child next month.              | 6. Grandma might learn karate.                  |
| 2. Mr. Rose should be making dinner by now.           | 7. I have seen snow in Telluride in July.       |
| 3. Temperatures are climbing.                         | 8. Antal will play guitar in a concert tonight. |
| 4. You do want dessert, right?                        | 9. Dad was praising the dog.                    |
| 5. I might go to community college for my first year. | 10. I am getting a job next semester.           |

### Writing and Speaking Application

Write three sentences that use verb phrases, and underline the helping verbs. Then, read your sentences to a partner. Your partner should identify the main verbs. Switch roles with your partner and repeat the exercise.

Name \_\_\_\_\_ Date \_\_\_\_\_

## 6 ADJECTIVES

**An adjective is a word used to describe a noun or pronoun or to give it a more specific meaning.**

An adjective answers one of four questions about a noun or pronoun: *What kind? Which one? How many? How much?* See the examples in the table below.

<u>beautiful</u> gardens	What kind of gardens?
<u>that</u> lesson	Which lesson?
<u>sixty-seven</u> years	How many years?
<u>boundless</u> energy	How much energy?

### Practice A Identifying Adjectives

Read the sentences below. Then, underline the adjective or adjectives in each sentence. Remember that articles are adjectives, too!

**Example:** The tall, handsome boy goes to college.

**Answer:** The tall, handsome boy goes to college.

- |  |   |
|--|---|
| 1. That game went on forever!            | 6. The broken window lets in the cold.    |
| 2. I am listening to classical music.    | 7. She enjoys making complicated recipes. |
| 3. Cesar loves putt-putt golf.           | 8. The old, slow computer has to go.      |
| 4. Some people spend long hours at work. | 9. Modern art speaks to my soul.          |
| 5. Allen wants a red suit.               | 10. Reading is my favorite activity.      |

### Practice B Identifying Nouns Used as Adjectives

Read each sentence. Then, write the noun that is used as an adjective in each sentence.

**Example:** She went to the work meeting.

**Answer:** work

1. It is time to wash the dinner dishes. \_\_\_\_\_
2. Did you bring a winter coat? \_\_\_\_\_
3. I missed band practice all week. \_\_\_\_\_
4. Nguyen is a basketball player. \_\_\_\_\_
5. Camilla has a smoothie habit. \_\_\_\_\_
6. That office building should be torn down. \_\_\_\_\_
7. The earthquake plan is very detailed. \_\_\_\_\_
8. Miss Stenberg has fruit salad for lunch. \_\_\_\_\_
9. He works at an airplane factory. \_\_\_\_\_
10. She is hoping for an adventure vacation. \_\_\_\_\_

### Writing and Speaking Application

Write a three-sentence description of your family, using at least one adjective in every sentence. Circle the adjectives. Find a partner and take turns reading your sentences. Your partner should listen for and name the adjective or adjectives in each sentence. Then, switch roles with your partner.

**LESSON**  
**16-3**

# Corresponding Parts of Similar Figures

## Reading Strategies: Use a Venn Diagram

The Venn diagram shows that the figures in the inner oval contains all the properties of the figures in the outer oval.

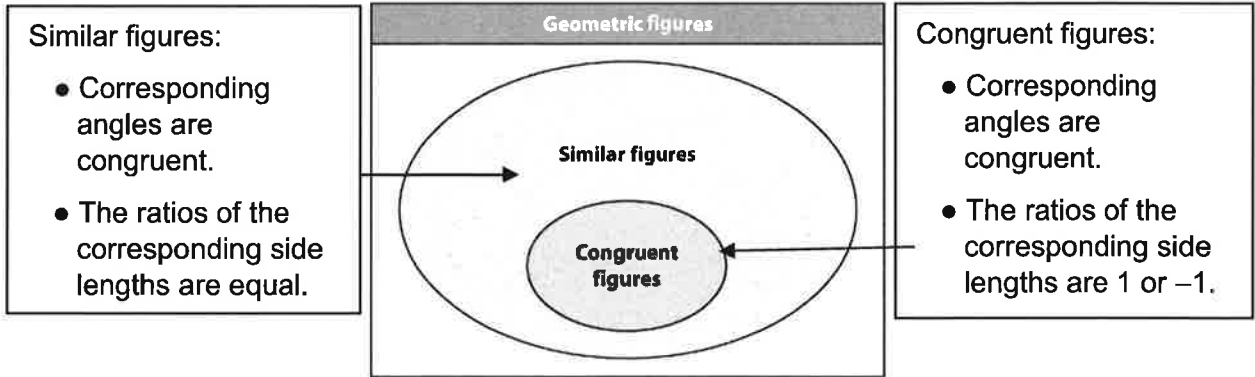

Use the Venn diagram above to answer Problems 1–6.

1. Is a pair of similar figures always a pair of congruent figures? \_\_\_\_\_

2. Is a pair of congruent figures always a pair of similar figures? \_\_\_\_\_

3. Is a pair of figures always similar or congruent? \_\_\_\_\_

4. A pair of figures is outside both ovals. What do you know about these figures?  
\_\_\_\_\_

5. In  $\triangle ABC$ ,  $m\angle A = 37^\circ$ ,  $m\angle B = 123^\circ$ , and  $m\angle C = 20^\circ$ .  
 $AB = 4$ ,  $BC = 7$ , and  $AC = 10$ .

In  $\triangle JKL$ ,  $m\angle J = 37^\circ$ ,  $m\angle K = 123^\circ$ , and  $m\angle L = 20^\circ$ .

$JK = 6$ ,  $KL = 10.5$ , and  $JL = 15$ .

Can  $\triangle ABC$  and  $\triangle JKL$  be classified as similar, congruent, both, or neither? Explain.  
\_\_\_\_\_

6. In Rectangle  $DEFG$ ,  $DE = 7$ ,  $EF = 3$ ,  $FG = 7$ , and  $DG = 3$ .

In Rectangle  $MNOP$ ,  $MN = 7$ ,  $NO = 3$ ,  $OP = 7$ , and  $MP = 3$ .

Can Rectangles  $DEFG$  and  $MNOP$  be classified as similar, congruent, both, or neither? Explain.  
\_\_\_\_\_



# The Paris Peace Conference and Treaty of Versailles of 1919

By Office of the Historian, adapted by Newsela staff on 01.04.18

Word Count **1,012**

Level **1040L**



Image 1. Crowds gather at Versailles Palace in France after the signing of the Treaty of Versailles on June 28, 1919. Photo from the public domain

Shortly after the end of World War I, the Paris Peace Conference was called to establish the terms of the peace. It took place in January 1919 at the palace of Versailles, just outside Paris.

Though nearly 30 nations participated, the representatives of four major powers largely controlled the proceedings: David Lloyd George of the United Kingdom, Georges Clemenceau of France, Woodrow Wilson of the United States and Vittorio Emanuele Orlando of Italy. These men became known as the "Big Four."

The Paris Peace Conference resulted in the drafting of the Treaty of Versailles. The Treaty reflected the compromises reached at the conference. It included plans to form the League of Nations, which was conceived as a way for nations to work out their differences peacefully. U.S. President Woodrow Wilson was a strong supporter of the League, as he believed it would prevent future wars.

## Complicated Negotiations

However, negotiations at the Paris Peace Conference were complicated. The United Kingdom, France and Italy had fought together as the Allied Powers, while the United States entered the war in April 1917 as an Associated Power. Although it fought alongside the Allies, the United States did not have to honor pre-existing agreements among the Allied Powers. These agreements focused on the redistribution of territories after the war. U.S. President Woodrow Wilson strongly opposed many of these arrangements. This often led to significant disagreements among the "Big Four."

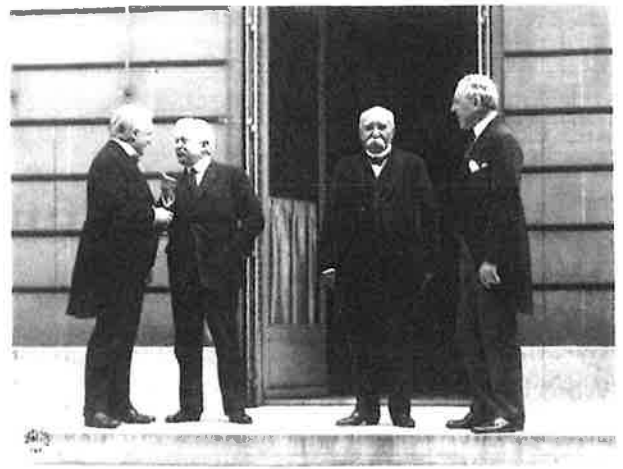

### **Promise That All Powers Would Disarm Equally**

Certain nations were excluded from the Treaty negotiations. One of these nations was Russia, whose communist government was not recognized by Allied powers. The defeated Central Powers — Germany, Austria-Hungary, Turkey and Bulgaria — were excluded from negotiations as well. This infuriated the German representatives, who had requested an end to the fighting on the assumption that Wilson's Fourteen Points would be maintained. The Fourteen Points were a series of measures conceived by Wilson to guarantee a just peace. They included the promise that all powers involved in the war would disarm equally. They also included the respect of national borders. Yet, at the urging of the French and British, the Treaty of Versailles punished Germany much more harshly than Wilson had intended.

The Treaty required the new German government to surrender approximately 10 percent of its prewar territory in Europe and all of its overseas possessions. It placed the harbor city of Danzig, now Gdansk, and the coal-rich Saarland under the administration of the League of Nations. The territories of Alsace and Lorraine were returned from Germany to France. Other German territories were transferred to Belgium and Denmark. Poland was given independence and a land corridor to the Baltic Sea, separating the region of East Prussia from the rest of Germany.

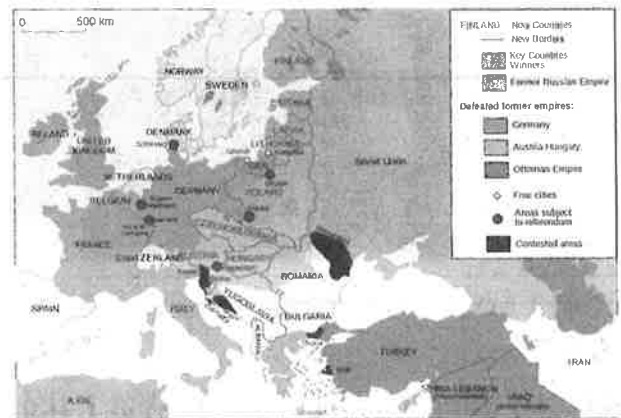

### **War Criminals**

The Treaty limited the size of the German army and navy. It also allowed for the trial of Kaiser Wilhelm II and a number of other high-ranking German officials as war criminals.

Under the terms of the Treaty, the Germans accepted responsibility for the war and agreed to pay financial reparations to the Allies. The amount owed was set at 132 billion gold Reichmarks, or 32 billion U.S. dollars. And that was on top of the initial \$5 billion payment demanded by the Treaty.

### **Germany Opposes Harsh Conditions**



The harsh conditions imposed by the Treaty of Versailles were bitterly opposed by Germany. The German Foreign Minister, Count von Brockdorff-Rantzau, wrote the following in a letter of complaint to Georges Clemenceau, who was president of the conference. He said the Germans "were firmly resolved to do everything in our power" to meet the "grave obligations which we had undertaken." At the same time, "we hoped for the peace of justice which had been promised to us." Now, that hope had been dashed. The Germans were horrified to learn of the Treaty's demands.



### "Death Sentence"

Brockdorff-Rantzau said that Germany had been cut in pieces and weakened. Now, the country also had to "bear all the war expenses of her enemies." He claimed those expenses were many times greater than the total amount of German public and private wealth. He said that a debt this size made it impossible for Germany to rebuild herself. In other words, the Allied powers were asking a whole people to sign their own "death sentence."

### Paving The Way For Hitler

In the years that followed, the Allies would at first attempt to enforce the original terms. However, the Treaty went through revisions, many of which lessened the demands made of Germany. Despite this, many Germans remained deeply resentful. Their resentment helped pave the way for the rise of Adolf Hitler's Nazi Party. In the years that followed the Treaty, Germany began rebuilding its armed forces.



The Treaty was also criticized by individuals from the winning countries. In 1919, the British economist John Maynard Keynes wrote the following in his book "The Economic Consequences of the Peace." He said that driven "by insane and reckless self-regard," Germany had done great damage to Europe. But France and Britain had "run the risk of completing the ruin." Keynes said that, instead of restoring peace and economic well-being, the Peace of Paris would damage Europe further. He added that by abusing their power as victors, and destroying a weakened Germany and Austria-Hungary, France and Italy were inviting their own destruction. According to Keynes, both sides of the war were deeply connected by hidden economic bonds. If one side collapsed, the other would suffer as well.

Explain the Effects of Treaty of Versailles of 1919:

Complicated Negotiations

Promise That All Powers Would Disarm Equally

War Criminals

Death Sentence

Paving The Way For Hitler

## Quiz

1 Read the selection from the section "War Criminals."

*Under the terms of the Treaty, the Germans accepted responsibility for the war and agreed to pay financial reparations to the Allies. The amount owed was set at 132 billion gold Reichmarks, or 32 billion U.S. dollars.*

Which two words would BEST replace "responsibility" and "reparations" in the selection above?

- (A) fault; penalties
- (B) ownership; dues
- (C) guilt; incentives
- (D) authority; damages

2 Read the selection from the section "Death Sentence."

*He said that a debt this size made it impossible for Germany to rebuild herself. In other words, the Allied powers were asking a whole people to sign their own "death sentence."*

Why did the author use the phrase "death sentence"?

- (A) to explain why the Treaty was harsh but fair when compared to the damage caused during World War I
- (B) to show that the Treaty helped certain countries while harming others
- (C) to describe one way in which the Treaty would help Germany pay for the destruction it had caused
- (D) to indicate that the Treaty ensured Germany would never be a successful country again

3 Which option accurately compares and contrasts how Image 1 and Image 5 affect the reader's understanding of the Treaty of Versailles?

- (A) Image 1 demonstrates the disagreements between members of the Big Four, while Image 5 shows united opposition from the people of Germany.
- (B) Image 1 explains the optimism about the Treaty from the winning countries, while Image 5 shows similar excitement from the people of Germany.
- (C) Image 1 shows excitement about the Treaty in the victorious nations, while Image 5 highlights how Germany reacted to the Treaty.
- (D) Image 1 describes the uncertainty of the Treaty, while Image 5 captures the frustration present in the defeated countries.

4 Which conclusion is supported in both Image 3 and the article?

- (A) The Treaty of Versailles required every nation that fought in the war to give up some territory.
- (B) The Treaty of Versailles changed the borders of several nations across Europe.
- (C) The Treaty of Versailles was developed specifically to gain access to German territory.
- (D) The Treaty of Versailles requested but did not require countries to surrender any of their pre-war lands.





# Compton USD Learning Packet

## High School ELD

**English Language  
Development (ELD)**





# The Necklace

Guy de Maupassant  
translated by Andrew MacAndrew

## BACKGROUND

In the late nineteenth century, a type of literature known as Realism emerged as a reaction to the idealism and optimism of Romantic literature. Realism sought to describe life as it is, without ornament or glorification. “The Necklace,” an example of Realist fiction, tells the story of an average woman who pays a significant price to experience a glamorous evening. As in all Realist fiction, there is no fairy-tale ending.

SCAN FOR  
MULTIMEDIA 

- 1 **S**he was one of those pretty, charming young women who are born, as if by an error of Fate, into a petty official’s family. She had no dowry,<sup>1</sup> no hopes, not the slightest chance of being appreciated, understood, loved, and married by a rich and distinguished man; so she slipped into marriage with a minor civil servant at the Ministry of Education.
- 2 Unable to afford jewelry, she dressed simply: but she was as wretched as a *déclassée*, for women have neither caste nor breeding—in them beauty, grace, and charm replace pride of birth. Innate **refinement**, instinctive elegance, and **suppleness** of wit give them their place on the only scale that counts, and these qualities make humble girls the peers of the grandest ladies.
- 3 She suffered constantly, feeling that all the attributes of a gracious life, every luxury, should rightly have been hers. The poverty of her rooms—the shabby walls, the worn furniture, the ugly

## NOTES

**refinement** (rih FYN muhnt) *n.*  
politeness; good manners

**suppleness** (SUHP uhl nihz) *n.*  
smoothness; fluidity; ability  
to adapt easily to different  
situations

1. **dowry** (DOW ree) *n.* wealth or property given by a woman’s family to her husband upon their marriage.



NOTES

**CLOSE READ**

**ANNOTATE:** In paragraph 3, mark details related to size, luxury, and antiquity.

**QUESTION:** Why does the author use these particular details?

**CONCLUDE:** What image do these details paint of the life Madame Loisel desires?

**exquisite** (EHKS kwih zihht) *adj.*  
very beautiful or lovely

**gallantries** (GAL uhn treeez) *n.*  
acts of polite attention to the needs of women

upholstery—caused her pain. All these things that another woman of her class would not even have noticed, tormented her and made her angry. The very sight of the little Breton girl who cleaned for her awoke rueful thoughts and the wildest dreams in her mind. She dreamed of thick-carpeted reception rooms with Oriental hangings, lighted by tall, bronze torches, and with two huge footmen in knee breeches, made drowsy by the heat from the stove, asleep in the wide armchairs. She dreamed of great drawing rooms upholstered in old silks, with fragile little tables holding priceless knick-knacks, and of enchanting little sitting rooms redolent of perfume, designed for teatime chats with intimate friends—famous, sought-after men whose attentions all women longed for.

4 When she sat down to dinner at her round table with its three-day old cloth, and watched her husband opposite her lift the lid of the soup tureen and exclaim, delighted: "Ah, a good homemade beef stew! There's nothing better . . ." she would visualize elegant dinners with gleaming silver amid tapestried walls peopled by knights and ladies and exotic birds in a fairy forest; she would think of **exquisite** dishes served on gorgeous china, and of **gallantries** whispered and received with sphinx-like smiles while eating the pink flesh of trout or wings of grouse.

5 She had no proper wardrobe, no jewels, nothing. And those were the only things that she loved—she felt she was made for them. She would have so loved to charm, to be envied, to be admired and sought after.

6 She had a rich friend, a schoolmate from the convent she had attended, but she didn't like to visit her because it always made her so miserable when she got home again. She would weep for whole days at a time from sorrow, regret, despair, and distress.

7 Then one evening her husband arrived home looking triumphant and waving a large envelope.

8 "There," he said, "there's something for you."

9 She tore it open eagerly and took out a printed card which said:

10 "The Minister of Education and Madame Georges Ramponneau<sup>2</sup> request the pleasure of the company of M. and Mme. Loisel<sup>3</sup> at an evening reception at the Ministry on Monday, January 18th."

11 Instead of being delighted, as her husband had hoped, she tossed the invitation on the table and muttered, annoyed:

12 "What do you expect me to do with that?"

13 "Why, I thought you'd be pleased, dear. You never go out and this would be an occasion for you, a great one! I had a lot of trouble getting it. Everyone wants an invitation: they're in great demand and there are only a few reserved for the employees. All the officials will be there."

14 She looked at him, irritated, and said impatiently:

2. **Georges** (zhawrzh) **Ramponneau** (ram puh NOH)

3. **Loisel** (lwah ZEHL)

15 “I haven’t a thing to wear. How could I go?”

16 It had never even occurred to him. He stammered:

17 “But what about the dress you wear to the theater? I think it’s lovely. . . .”

18 He fell silent, amazed and bewildered to see that his wife was crying. Two big tears escaped from the corners of her eyes and rolled slowly toward the corners of her mouth. He mumbled:

19 “What is it? What is it?”

20 But, with great effort, she had overcome her misery; and now she answered him calmly, wiping her tear-damp cheeks:

21 “It’s nothing. It’s just that I have no evening dress and so I can’t go to the party. Give the invitation to one of your colleagues whose wife will be better dressed than I would be.”

22 He was overcome. He said:

23 “Listen, Mathilde, how much would an evening dress cost—a suitable one that you could wear again on other occasions, something very simple?”

24 She thought for several seconds, making her calculations and at the same time estimating how much she could ask for without eliciting an immediate refusal and an exclamation of horror from this economical government clerk.

25 At last, not too sure of herself, she said:

26 “It’s hard to say exactly but I think I could manage with four hundred francs.”

27 He went a little pale, for that was exactly the amount he had put aside to buy a rifle so that he could go hunting the following summer near Nanterre, with a few friends who went shooting larks around there on Sundays.

28 However, he said:

29 “Well, all right, then. I’ll give you four hundred francs. But try to get something really nice.”

30 As the day of the ball drew closer, Madame Loisel seemed depressed, disturbed, worried—despite the fact that her dress was ready. One evening her husband said:

31 “What’s the matter? You’ve really been very strange these last few days.”

32 And she answered:

33 “I hate not having a single jewel, not one stone, to wear. I shall look so dowdy.<sup>4</sup> I’d almost rather not go to the party.”

34 He suggested:

35 “You can wear some fresh flowers. It’s considered very chic<sup>5</sup> at this time of year. For ten francs you can get two or three beautiful roses.”

36 That didn’t satisfy her at all.

37 “No . . . there’s nothing more humiliating than to look poverty-stricken among a lot of rich women.”

38 Then her husband exclaimed:

4. **dowdy** *adj.* shabby.

5. **chic** (*sheek*) *adj.* fashionable.



**resplendent** (rih SPLEHN duhnt) *adj.* dazzling; gorgeous

**homage** (OM ihj) *n.* something done to honor someone

- 39 “Wait—you silly thing! Why don’t you go and see Madame Forestier<sup>6</sup> and ask her to lend you some jewelry. You certainly know her well enough for that, don’t you think?”
- 40 She let out a joyful cry.
- 41 “You’re right. It never occurred to me.”
- 42 The next day she went to see her friend and related her tale of woe.
- 43 Madame Forestier went to her mirrored wardrobe, took out a big jewel case, brought it to Madame Loisel opened it, and said:
- 44 “Take your pick, my dear.”
- 45 Her eyes wandered from some bracelets to a pearl necklace, then to a gold Venetian cross set with stones, of very fine workmanship. She tried on the jewelry before the mirror, hesitating, unable to bring herself to take them off, to give them back. And she kept asking:
- 46 “Do you have anything else, by chance?”
- 47 “Why yes. Here, look for yourself. I don’t know which ones you’ll like.”
- 48 All at once, in a box lined with black satin, she came upon a superb diamond necklace, and her heart started beating with overwhelming desire. Her hands trembled as she picked it up. She fastened it around her neck over her high-necked dress and stood there gazing at herself ecstatically.
- 49 Hesitantly, filled with terrible anguish, she asked:
- 50 “Could you lend me this one—just this and nothing else?”
- 51 “Yes, of course.”
- 52 She threw her arms around her friend’s neck, kissed her ardently, and fled with her treasure.
- 53 The day of the party arrived. Madame Loisel was a great success. She was the prettiest woman there—**resplendent**, graceful, beaming, and deliriously happy. All the men looked at her, asked who she was, tried to get themselves introduced to her. All the minister’s aides wanted to waltz with her. The minister himself noticed her.
- 54 She danced enraptured—carried away, intoxicated with pleasure, forgetting everything in this triumph of her beauty and the glory of her success, floating in a cloud of happiness formed by all this **homage**, all this admiration, all the desires she had stirred up—by this victory so complete and so sweet to the heart of a woman.
- 55 When she left the party, it was almost four in the morning. Her husband had been sleeping since midnight in a small, deserted sitting room, with three other gentlemen whose wives were having a wonderful time.
- 56 He brought her wraps so that they could leave and put them around her shoulders—the plain wraps from her everyday life whose shabbiness jarred with the elegance of her evening dress. She felt this and wanted to escape quickly so that the other women, who were enveloping themselves in their rich furs, wouldn’t see her.

6. **Forestier** (fawr ehs TYAY)

57 Loisel held her back.

58 "Wait a minute. You'll catch cold out there. I'm going to call a cab."

59 But she wouldn't listen to him and went hastily downstairs.

Outside in the street, there was no cab to be found; they set out to look for one, calling to the drivers they saw passing in the distance.

60 They walked toward the Seine,<sup>7</sup> shivering and miserable. Finally, on the embankment, they found one of those ancient nocturnal broughams<sup>8</sup> which are only to be seen in Paris at night, as if they were ashamed to show their shabbiness in daylight.

61 It took them to their door in the Rue des Martyrs, and they went sadly upstairs to their apartment. For her, it was all over. And he was thinking that he had to be at the Ministry by ten.

62 She took off her wraps before the mirror so that she could see herself in all her glory once more. Then she cried out. The necklace was gone; there was nothing around her neck.

63 Her husband, already half undressed, asked:

64 "What's the matter?"

65 She turned toward him in a frenzy:

66 "The . . . the . . . necklace—it's gone."

67 He got up, thunderstruck.

68 "What did you say? . . . What! . . . Impossible!"

69 And they searched the folds of her dress, the folds of her wrap, the pockets, everywhere.

70 They didn't find it.

71 He asked:

72 "Are you sure you still had it when we left the ball?"

73 "Yes. I remember touching it in the hallway of the Ministry."

74 "But if you had lost it in the street, we would have heard it fall. It must be in the cab."

75 "Yes, most likely. Do you remember the number?"

76 "No. What about you—did you notice it?"

77 "No. "

78 They looked at each other in utter dejection. Finally Loisel got dressed again.

79 "I'm going to retrace the whole distance we covered on foot," he said, "and see if I can't find it."

80 And he left the house. She remained in her evening dress, too weak to go to bed, sitting crushed on a chair, lifeless and blank.

81 Her husband returned at about seven o'clock. He had found nothing.

82 He went to the police station, to the newspapers to offer a reward, to the offices of the cab companies—in a word, wherever there seemed to be the slightest hope of tracing it.

Then she cried out.  
The necklace was gone;  
there was nothing  
around her neck.

#### CLOSE READ

**ANNOTATE:** In paragraphs 66–68, mark the punctuation that suggests hesitation or speech that is broken up in some way.

**QUESTION:** Why does the author use these punctuation marks? What emotions do they convey?

**CONCLUDE:** How does the punctuation add to the effect of the dialogue?

7. **Seine** (sayn) river flowing through Paris.

8. **broughams** (broomz) *n.* horse-drawn carriages.

- 83 She spent the whole day waiting, in a state of utter hopelessness  
before such an appalling catastrophe.
- 84 Loisel returned in the evening, his face lined and pale; he had  
learned nothing.
- 85 "You must write to your friend," he said, "and tell her that you've  
broken the clasp of the necklace and that you're getting it mended.  
That'll give us time to decide what to do."
- 86 She wrote the letter at his dictation.
- 87 By the end of the week, they had lost all hope.
- 88 Loisel, who had aged five years, declared:
- 89 "We'll have to replace the necklace."
- 90 The next day they took the case in which it had been kept and  
went to the jeweler whose name appeared inside it. He looked  
through his ledgers:
- 91 "I didn't sell this necklace, madame. I only supplied the case."
- 92 Then they went from one jeweler to the next, trying to find a  
necklace like the other, racking their memories, both of them sick  
with worry and distress.
- 93 In a fashionable shop near the Palais Royal, they found a diamond  
necklace which they decided was exactly like the other. It was worth  
40,000 francs. They could have it for 36,000 francs.
- 94 They asked the jeweler to hold it for them for three days, and they  
stipulated that he should take it back for 34,000 francs if the other  
necklace was found before the end of February.
- 95 Loisel possessed 18,000 francs left him by his father. He would  
borrow the rest.
- 96 He borrowed, asking a thousand francs from one man, five  
hundred from another, a hundred here, fifty there. He signed  
promissory notes,<sup>9</sup> borrowed at exorbitant rates, dealt with usurers  
and the entire race of moneylenders. He compromised his whole  
career, gave his signature even when he wasn't sure he would be  
able to honor it, and horrified by the anxieties with which his future  
would be filled, by the black misery about to descend upon him, by  
the prospect of physical privation and moral suffering, went to get  
the new necklace, placing on the jeweler's counter 36,000 francs.
- 97 When Madame Loisel went to return the necklace, Madame  
Forestier said in a faintly waspish tone:
- 98 "You could have brought it back a little sooner! I might have  
needed it."
- 99 She didn't open the case as her friend had feared she might. If she  
had noticed the substitution, what would she have thought? What  
would she have said? Mightn't she have taken Madame Loisel for  
a thief?

9. **promissory** (PROM uh sawr ee) **notes** written promises to pay back borrowed money.

100 Madame Loisel came to know the awful life of the poverty-stricken. However, she resigned herself to it with unexpected fortitude. The crushing debt had to be paid. She would pay it. They dismissed the maid; they moved into an attic under the roof.

101 She came to know all the heavy household chores, the loathsome work of the kitchen. She washed the dishes, wearing down her pink nails on greasy casseroles and the bottoms of saucepans. She did the laundry, washing shirts and dishcloths which she hung on a line to dry; she took the garbage down to the street every morning, and carried water upstairs, stopping at every floor to get her breath. Dressed like a working-class woman, she went to the fruit store, the grocer, and the butcher with her basket on her arm, bargaining, outraged, contesting each sou<sup>10</sup> of her pitiful funds.

102 Every month some notes had to be honored and more time requested on others.

103 Her husband worked in the evenings, putting a shopkeeper's ledgers in order, and often at night as well, doing copying at twenty-five centimes a page.

104 And it went on like that for ten years.

105 After ten years, they had made good on everything, including the usurious rates and the compound interest.

106 Madame Loisel looked old now. She had become the sort of strong woman, hard and coarse, that one finds in poor families. Disheveled, her skirts askew, with reddened hands, she spoke in a loud voice, slopping water over the floors as she washed them. But sometimes, when her husband was at the office, she would sit down by the window and muse over that party long ago when she had been so beautiful, the belle of the ball.

107 How would things have turned out if she hadn't lost that necklace? Who could tell? How strange and fickle life is! How little it takes to make or break you!

108 Then one Sunday when she was strolling along the Champs-Élysées<sup>11</sup> to forget the week's chores for a while, she suddenly caught sight of a woman taking a child for a walk. It was Madame Forestier, still young, still beautiful, still charming.

109 Madame Loisel started to tremble. Should she speak to her? Yes, certainly she should. And now that she had paid everything back, why shouldn't she tell her the whole story?

110 She went up to her.

111 "Hello, Jeanne."

112 The other didn't recognize her and was surprised that this plainly dressed woman should speak to her so familiarly. She murmured:

113 "But . . . madame! . . . I'm sure . . . You must be mistaken."

10. **sou** (soo) *n.* former French coin, worth very little; the centime (SAHN teem), mentioned later, was also of little value.

11. **Champs-Élysées** (SHAHN zay lee ZAY) fashionable street in Paris.

## NOTES

### CLOSE READ

ANNOTATE: Mark the shortest sentence in paragraph 100.

QUESTION: How is this sentence different from the others in the paragraph?

CONCLUDE: What effect does this short sentence create that a longer sentence might not?

### CLOSE READ

ANNOTATE: Underline the repeated word in paragraph 108.

QUESTION: Why does the author repeat this word?

CONCLUDE: What is the effect of this repetition?

- 114 "No, I'm not. I am Mathilde Loisel."
- 115 Her friend gave a little cry.
- 116 "Oh! Oh, my poor Mathilde, how you've changed!"
- 117 "Yes, I've been through some pretty hard times since I last saw you  
and I've had plenty of trouble—and all because of you!"
- 118 "Because of me? What do you mean?"
- 119 "You remember the diamond necklace you lent me to wear to the  
party at the Ministry?"
- 120 "Yes. What about it?"
- 121 "Well, I lost it."
- 122 "What are you talking about? You returned it to me."
- 123 "What I gave back to you was another one just like it. And it took  
us ten years to pay for it. You can imagine it wasn't easy for us, since  
we were quite poor. . . . Anyway, I'm glad it's over and done with."
- 124 Madame Forestier stopped short.
- 125 "You say you bought a diamond necklace to replace that  
other one?"
- 126 "Yes. You didn't even notice then? They really were exactly alike."
- 127 And she smiled, full of a proud, simple joy.
- 128 Madame Forestier, profoundly moved, took Mathilde's hands in  
her own.
- 129 "Oh, my poor, poor Mathilde! Mine was false. It was worth five  
hundred francs at the most!"

## The Necklace (short story)

English	Name
Unit 4	The Necklace
<p>Questions Write one question for each vocabulary term</p> <p>1.</p> <p>2.</p> <p>3.</p> <p>4.</p> <p>5.</p>	<p>Notetaking Column</p> <p>Irony The difference between what we expect or what seems suitable in relation to what actually happens and there are three different types of irony.</p> <p>Verbal Irony Occurs when someone <i>says</i> something but <i>means</i> the opposite.</p> <ul style="list-style-type: none"> <li>● Example</li> <li>● "Nice day," you say as you slog through flood water up to your waist.</li> </ul> <p>Situational Irony Refers to an event that is <i>contrary to</i>, or the opposite of what we expected.</p> <ul style="list-style-type: none"> <li>● Example</li> <li>● The winner of the wrestling match is the weakest team member.</li> </ul> <p>Dramatic Irony Takes place when we know what is going to happen to a character but the character does not know.</p> <ul style="list-style-type: none"> <li>● Example</li> <li>● We know, but the robbers do not know, that the hotel they plan to rob is hosting a police convention.</li> </ul> <p>Tone Writer/speaker's attitude towards the characters, subject, and or audience.</p>
Summary	Write a 2 - 3 sentence summary based on the definitions you learned.

## ***The Necklace* (short story)**

<b>PLOT STRUCTURE TEXT DIAGRAM ELEMENTS</b>	<b>POSSIBLE RESPONSES</b>
<b>CHARACTERS</b>	
<b>Protagonist and Main Character(s)</b>	
<b>Antagonist</b>	
<b>SETTING</b>	
<b>Time</b>	
<b>Place</b>	
<b>CONFLICT</b>	
<b>TURNING POINT</b>	
<b>RISING ACTION</b>	
<b>FALLING ACTION</b>	
<b>THEME</b>	

# **Learning Packet**

## **Answer Key**



# Part 1: Grammar Practice Answers

## Chapter 13 Nouns (1)

### Practice A Identifying Nouns

1. The present is on the table.
2. Please take Sally to the dentist.
3. My brother slept through the movie.
4. Call the office after the package arrives.
5. The weather in Chicago is cold in January.
6. The firefighter received a medal for her bravery.
7. Her family moved to the United States from China.
8. Gymnastics requires balance and strength.
9. Our choir visited the White House in Washington, D.C.
10. The friendship between Rich and Tom has lasted for years.

### Practice B Labeling Nouns

1. friendship—common, abstract
2. Aunt Mary—proper, concrete;  
family—common, concrete
3. potatoes—common, concrete
4. uncle—common, concrete;  
Florida—proper, concrete
5. puppy—common, concrete;  
attention—common, abstract
6. telephone—common, concrete;  
Grandpa—proper, concrete
7. hope—common, abstract;  
freedom—common, abstract
8. *Tom Sawyer*—proper, concrete;  
Mark Twain—proper, concrete
9. frustration—common, abstract;  
time—common, abstract
10. bridge—common, concrete;  
Brooklyn Bridge—proper, concrete

## Chapter 13 Pronouns (2)

### Practice A Identifying Antecedents

1. Mary
2. Jamal
3. students
4. Rachel
5. Andrew
6. Roderick
7. Jessie
8. Dennis
9. Kate
10. Cameron

### Practice B Identifying Reciprocal Pronouns

1. each other
2. one another
3. each other
4. one another
5. one another

## Chapter 13 Action Verbs and Linking Verbs (3)

### Practice A Identifying Action Verbs

1. plays
2. works
3. drank
4. helps
5. cooks
6. swam

### Practice B Identifying Linking Verbs

1. is
2. sounds
3. became

4. felt
5. appeared

**Practice C Distinguishing Between Action Verbs and Linking Verbs**

1. became—linking verb
2. played—action verb
3. was—linking verb
4. is—linking verb
5. argued—action verb

**Chapter 13 Transitive and Intransitive Verbs (4)**

**Practice A Identifying Transitive Verbs and Their Objects**

Students will underline the first term and circle the second.

1. sold—hot chocolate
2. wore—glasses
3. ate—all
4. scratched—hand
5. pictured—success
6. took—garbage
7. forgot—backpack
8. asked—questions
9. ate—leftovers
10. washed—hands

**Practice B Distinguishing Between Transitive and Intransitive Verbs**

1. walked—intransitive
2. did—transitive
3. played—transitive
4. grew—intransitive
5. holds—transitive
6. sprained—transitive
7. runs—intransitive
8. wants—transitive
9. forgot—transitive
10. washed—transitive

**Chapter 13 Verb Phrases (5)**

**Practice A Recognizing Verb Phrases**

1. should have finished
2. is leaving
3. is painting
4. was expecting
5. does use
6. have seen
7. will be working
8. has been posting
9. is raising
10. is planning

**Practice B Identifying Helping Verbs and Main Verbs**

Students will underline the first term and circle the second.

1. are—adopting
2. should be—making
3. are—climbing
4. do—want
5. might—go
6. might—learn
7. have—seen
8. will—play
9. was—praising
10. am—getting

**Chapter 13 Adjectives (6)**

**Practice A Identifying Adjectives**

1. that
2. classical
3. putt-putt
4. some, long
5. red
6. the broken, the
7. complicated
8. the old, slow
9. modern
10. my favorite

### Practice B Identifying Nouns Used as Adjectives

1. dinner
2. winter
3. band
4. basketball
5. smoothie
6. office
7. earthquake
8. fruit
9. airplane
10. adventure

### Chapter 13 Adverbs (7)

#### Practice A Recognizing Adverbs

1. loudly
2. anywhere
3. abroad
4. underground
5. accidentally
6. always
7. finally
8. soon
9. tomorrow
10. cheerfully

#### Practice B Identifying Adverbs and the Words They Modify

1. utterly—wonderful
2. seldom—rings
3. upwardly—mobile
4. sometimes—appreciate
5. usually—arrives
6. often—practices
7. swiftly—dropped
8. thoughtfully—practices
9. soon—will move
10. mortally—was wounded

### Chapter 13 Prepositions and Prepositional Phrases (8)

#### Practice A Identifying Prepositions and Prepositional Phrases

1. on the table
2. of Tricia's
3. in the morning
4. between the two brothers
5. in the sink
6. in San Diego
7. under the bed
8. into the night
9. without your hat
10. on the beach

#### Practice B Identifying Prepositions and Their Objects

Students will underline the first term and circle the second.

1. at—sunset
2. because—problem
3. in—park
4. near—ocean
5. toward—shore
6. for—years
7. of—musician
8. to—work
9. with—music
10. for—transportation

### Chapter 13 Conjunctions (9)

#### Practice A Identifying Conjunctions

1. but
2. either...or
3. and
4. or
5. after

6. when
7. but
8. either...or
9. not only...but also
10. while

### Practice B Identifying Kinds of Conjunctions

1. yet—coordinating
2. but—coordinating
3. while—subordinating
4. but—coordinating
5. either...or—correlative
6. and—coordinating
7. whether...or—correlative
8. or—coordinating
9. while—subordinating
10. but—coordinating

### Chapter 13 Interjections (10)

#### Practice A Identifying Interjections

1. Oh!
2. Goodness!
3. Pssst
4. Tsk-tsk
5. Ouch!
6. Hurray!
7. Alas
8. Whew!
9. Congratulations!
10. Whoa!

#### Practice B Supplying Interjections

Answers may vary. Sample answers are given.

1. Shhhh!
2. Ugh!
3. EEEK!
4. Yuck!

5. Pow!
6. Oh, well.
7. Congratulations!
8. Alas!
9. Whoops!
10. Howdy!

### Chapter 13 Identifying Parts of Speech (11)

#### Practice A Identifying Parts of Speech: Nouns, Pronouns, Verbs, Adjectives, and Adverbs

1. pronoun
2. verb
3. noun
4. adjective
5. adverb

#### Practice B Identifying Parts of Speech: Prepositions, Conjunctions, and Interjections

1. preposition
2. interjection
3. preposition
4. conjunction
5. conjunction

3. compliant; I was *compliant* with all their demands.
4. Chaplinesque; He had a *Chaplinesque* gift for using body language.

**B Sample answers:**

1. N; to demolish something means to knock it down. After *demolishing* the old building, they hauled away the rubble.
2. N; someone who is acquitted is found innocent of a crime. At the trial, the prisoner was *acquitted* and released.
3. Y; to acknowledge means to recognize something.
4. Y; to decelerate means to slow down.

**Grammar: Regular Verbs**

**Practice, p. 64**

- A**
1. (completed for student)
  2. stop, stopping, stopped, stopped
  3. play, playing, played, played
  4. hire, hiring, hired, hired
  5. confuse, confusing, confused, confused
- B**
1. present; 2. past participle
  3. present participle; 4. past participle; 5. past

**Assess, p. 65**

- A**
1. contain, containing, contained, contained
  2. clap, clapping, clapped, clapped
  3. whistle, whistling, whistled, whistled
  4. fold, folding, folded, folded
  5. practice, practicing, practiced, practiced
  6. wiggle, wiggling, wiggled, wiggled
- B**
1. present; 2. present participle
  3. past participle; 4. past; 5. present participle
  6. past participle
- C Sample answers:**
1. The team exercises before practice.
  2. My brother can't stop biting his nails.
  3. I tripped on the stairs.
  4. The animal shelter has rescued many dogs and cats.

**Grammar: Irregular Verbs**

**Practice, p. 66**

- A**
1. running, ran
  2. brought, bringing
  3. sent, sent
  4. cost, costs
  5. rise, risen
- B**
1. knew; 2. hurt; 3. left

**Assess, p. 67**

- A**
1. drawn; 2. worn; 3. swam; 4. sunk; 5. frozen
  6. taken; 7. rode; 8. taken; 9. fell; 10. drunk

- B**
1. gave; 2. stung; 3. left; 4. frozen; 5. taught
  6. lent; 7. eaten; 8. broke

**Grammar: Verb Tenses**

**Practice, p. 68**

- A**
1. remembered; 2. learned; 3. will live
  4. cooked; 5. uses
- B**
1. expected; 2. are; 3. was
  4. arrive; 5. got

**Assess, p. 69**

- A**
1. A; 2. D; 3. C; 4. B; 5. D; 6. A
- B**
1. works; 2. had gone; 3. propped
  4. will fail; 5. plans

**Writing: Alternative Ending**

**Practice, p. 70**

1. A.; 2. D.

**Assess, p. 71**

**Sample answer:**

"Are they your men?" asked Georg. "Are they your men?" he repeated impatiently as Ulrich did not answer.

"Yes," replied Ulrich. "We'll be freed soon." After being rescued, the two men kept their promise. While they did not become friends, they returned to their normal lives. A few years later, Ulrich's son and Georg's daughter married. Their family feud was finally and fully over.

**Writing: News Story**

**Practice, p. 72**

- A**
- Who?* the Carpenter family  
*What?* saved from tragedy by their family dog  
*When?* early Tuesday  
*Where?* their family home  
*Why?* Tommy was protective of the family.  
*How?* Tommy woke them when the fire started.
- B**
- The first sentence makes the reader want to know what the tragedy was and how the dog saved them.

**Assess, p. 73**

**Sample Answers:**

- A**
- Who?* a new student, Jan Golchecki  
*What?* moved to our town from Germany  
*When?* the beginning of the school year  
*Where?* here at Roper High  
*Why?* Her father was stationed in Germany and transferred here.  
*How?* flew from Germany on a military transport

- B** What is it like coming back to America after living in Germany for three years? Our newest student, Jan Golchecki, can tell you. She just moved to Middleton from Munich, Germany, two days before school started here at Roper High. Her father, a colonel in the army, was stationed in Germany and was just transferred back here. Jan, her family, and all their belongings were flown on a military transport plane to the base here. So when you see Jan in the halls, be sure to tell her, "Welcome home!"

### Writing: Short Story

#### Practice, p. 74

**A** Sample answers:

1. first person point of view
2. A. She is shy; she is 14 years old; she has long blond hair.  
B. She is shy and feels uncomfortable around the other students.
3. a dense forest of huge ferns; thick fog on the ground; a large, frightening animal

**B** Sample answers:

Maria grabbed my hand. "What was that?" she said, her voice trembling.

"I don't know, but it sounds big," I answered. "Maybe we should stay really quiet until it passes."

"Is that the best you can think of," she said, her voice rising. "You're the one who got us into this mess. How do you plan to get us out?"

#### Assess, p. 75

Students should demonstrate an understanding of the characteristics of a short story. Students should provide concrete sensory details that add vividness to the people, place, and events of the story.

### Literary Analysis: Character and Characterization

#### Practice, p. 76

**A** 1. Direct; 2. Indirect; 3. Indirect

**B** Sample answers:

1. "Roberto has arrived," said Roberto loudly. He handed his jacket to Rodney, the friend who followed him everywhere.; a top-brand sports shirt; He flexed his arm muscles so that others could admire them.; The other players looked at each other nervously.; Roberto is full of himself and likes to be the center of attention. He seems to be in shape and a good ball player.
2. Paula called the museum to find out what the hours were.; Then, she dug around in Susan's kitchen until she found the bus schedule.; She got Susan and Janet out the

door; Paula is a leader, the kind of person who takes charge and gets things done. She likes to be active.

#### Assess, p. 77

- A** 1. Direct; 2. Indirect; 3. Indirect  
4. Direct; 5. Indirect

**B** Sample answers:

She suspected that, as usual, Jack had gotten distracted and had forgotten all about it.; "Sure," said Jack. "A tiger escaped from the zoo, and the police are out warning people.;" "Jack," said his sister, "you aren't telling me one of your stories, by any chance?;" Jack is a dreamer, easily distracted. He tells tall tales and invents excuses for himself.

### Literary Analysis: Dialogue

#### Practice, p. 78

"I'm glad summer is coming.;" "I need a break.;" "You told me last time I came home that you had a lot of homework.;" "What else happened?;" "I joined the basketball team.;" "Whoah, little brother. You have to make sure you pace yourself.;" "I know.;" "It's probably even harder in college, right?"

1. Todd: It is almost summer. Todd is glad.
2. Todd: Todd needs a break.
3. Joe: Todd has a lot of homework. Joe is living away from home.
4. Joe: Joe does not talk to Todd every day.
5. Todd: Todd has joined the basketball team recently.
6. Joe: Joe is Todd's older brother.
7. Todd: Todd knows he has to pace himself.
8. Todd: Joe is in college.

#### Assess, p. 79

- A** 1. "You are doing a great job!"  
2. "Your painting is beautiful."  
3. "Let's go back."  
4. "Okay, I'll get the car."  
5. "Craig is always in a bad mood."

**B** Sample answers:

"What was that noise?" "Shhh." "That was just your nerves. Do you want to wake up the guard?" "Okay, Elaine, but I want you to know that I wouldn't be prowling around this museum basement if you were not my friend." "I know, Anna," "and believe me, I appreciate your help." "All right, ladies," "and just what is it that brings you to the museum basement in the middle of the night, might I ask?"

1. Anna: Anna hears a noise.
2. Elaine: Elaine thinks it's Anna's nerves and that she should be quiet or they will wake up a guard.

### Reteach 16-2: Proving Figures are Similar Using Transformations

1.  $y$ -axis
2. 3 units down and 1.5 units left
3. 2
- 4.

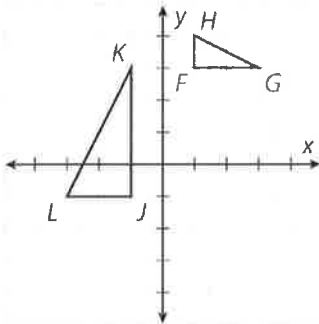

### Reteach 16-3: Corresponding Parts of Similar Figures

1.  $\angle F$
2.  $\frac{AB}{EF} = \frac{DC}{HG} = \frac{CB}{GF} = \frac{AD}{EH}$
3.  $70^\circ$
4. 12
5. 5

### Reteach 16-4: AA Similarity of Triangles

1.  $\overline{AB} \parallel \overline{DE}$
2.  $\angle 2 \cong \angle 3$
3.  $\angle 1 \cong \angle 4$
4. AA
5. 5
6. 12

### Reteach 17-1: Triangle Proportionality Theorem

1. 6
2. 10
3. No, because  $\frac{YZ}{ZV} \neq \frac{XW}{WV}$

### Reteach 17-2: Subdividing a Segment in a Given Ratio

1.  $(-4, -4)$
2.  $(2, 5)$
3. 9

4. 6
5.  $\frac{2}{3}, \frac{2}{3}$
6. 4, 6
7.  $(0, 2)$

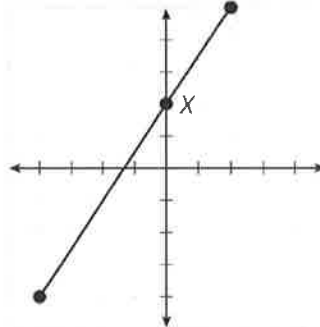

### Reteach 17-3: Using Proportional Relationships

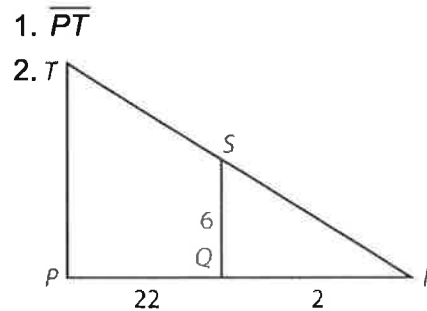

3.  $\triangle QRS \sim \triangle PRT$
4.  $\frac{PT}{QS} = \frac{PR}{QR}, \frac{PT}{6} = \frac{24}{2}$
5. 72 feet tall

### Reteach 17-4: Similarity in Right Triangles

1. 10
2. 30
3.  $\sqrt{96} = 4\sqrt{6} \approx 9.8$
4.  $\sqrt{18} = 3\sqrt{2} \approx 4.2$
5. 3
6.  $\sqrt{60} = 2\sqrt{15} \approx 7.7$

### Reteach 18-1: Tangent Ratio

1.  $\frac{5}{12}$
2.  $\frac{12}{5}$

**Practice and Problem Solving:****Modified 16-3**

1. proportional
2. similar
3. congruent
4.  $m\angle F$ ;  $m\angle G$ ;  $m\angle H$
5.  $DE$ ;  $GH$ ;  $FG$
6. equilateral
7. 15
8.  $30^\circ$
9. 24
10. 6

**Reading Strategies 16-3**

1. No
2. Yes
3. No
4. The figures don't have corresponding congruent angles, don't have corresponding side lengths that form equal ratios, or don't have both.
5. The triangles are similar because their corresponding angles are congruent and the ratios of the corresponding side lengths are equal, but not 1.
6. The rectangles are similar and congruent because their corresponding angles are congruent ( $90^\circ$ ) and the ratios of the corresponding side lengths are equal to 1.

**Success for English Learners**

1. Possible answer:  $\frac{WX}{RS} = \frac{XY}{ST}$
2. Possible answer: Substitute 2 for  $RS$ , 5 for  $WX$ , 8 for  $ST$ , and 20 for  $XY$  in  $\frac{RS}{WX} = \frac{ST}{XY}$  and check if the equation is true.
3.  $(2.5x, 2.5y)$

**LESSON 16-4****Practice and Problem Solving: A/B**

1. Possible answer:  $\angle ACB$  and  $\angle ECD$  are congruent vertical angles.  $m\angle B = m\angle D = 100^\circ$ , so  $\angle B \cong \angle D$ . Thus,  $\triangle ABC \sim \triangle EDC$  by AA.
2. Possible answer: Every equilateral triangle is also equiangular, so each angle in both triangles measures  $60^\circ$ . Thus,  $\triangle TUV \sim \triangle WXY$  by AA.
3. Possible answer: It is given that  $\angle JMN \cong \angle L$ .  $\frac{KL}{MN} = \frac{JL}{JM} = \frac{4}{3}$ . Thus,  $\triangle JLK \sim \triangle JMN$  by SAS.
4. Possible answer:  $\frac{PQ}{UT} = \frac{QR}{TS} = \frac{PR}{US} = \frac{3}{5}$ . Thus,  $\triangle PQR \sim \triangle UTS$  by SSS.
5. Possible answer:  $\angle C \cong \angle C$  by the Reflexive Property.  $\angle CGD$  and  $\angle F$  are right angles, so they are congruent. Thus,  $\triangle CDG \sim \triangle CEF$  by AA.  $DE = 9.75$ .

**Practice and Problem Solving: C**

1.  $\frac{13}{3}$ . Possible answer: Triangles  $UQV$  and  $SQT$  are similar to  $\triangle PQR$  by AA: they share  $\angle Q$ , and the other angles are congruent because they are the corresponding angles of parallel lines ( $\overline{UV}$ ,  $\overline{ST}$ , and  $\overline{PR}$ ) cut by transversals ( $\overline{PR}$  and  $\overline{RQ}$ ). Therefore, the corresponding sides of the triangles are proportional:  $\frac{PR}{UV} = \frac{PQ}{UQ}$ ;  $\frac{7}{2} = \frac{PQ}{3}$ ;  $PQ = 10.5$ .  $PQ = PS + SU + UQ$ ;  $10.5 = 4 + SU + 3$ ;  $SU = 3.5$ .  $\frac{ST}{UV} = \frac{SQ}{UQ}$ ;  $\frac{ST}{2} = \frac{6.5}{3}$ ;  $ST = \frac{13}{3}$ .
2. Possible answer: Triangles  $ABC$  and  $ADB$  both have a right angle and they share  $\angle A$ . Therefore, they are similar by AA. Triangles  $ABC$  and  $BDC$  both have a right angle and they share  $\angle C$ , so they are also similar by AA.  $m\angle ABD = 90^\circ - m\angle A$ , and  $m\angle CBD = 90^\circ - m\angle CBD$ , so  $m\angle A = m\angle CBD$ .



4. smaller
5. 80; 20; 2
6. transformations; similar

### Reading Strategies

1. Sequence of transformations: reflection and dilation
2. Single dilation

### Success for English Learners

1. A reduction
2. X is the image of Q, so X should lie at  $(2 \times 2.5, 4 \times 2.5)$ , or  $(5, 10)$ .

### LESSON 16-3

#### Practice and Problem Solving: A/B

1. He has switched the side lengths of the triangles in the last ratio of the proportion.

2. Possible answers:  $\frac{CD}{FG} = \frac{DE}{GH}$ ;  $\frac{CD}{FG} = \frac{CE}{FH}$ ;

$\frac{DE}{GH} = \frac{CE}{FH}$ ;  $m\angle C = m\angle F$ ;  $m\angle D = m\angle G$ ;  
 $m\angle E = m\angle H$

3. No. The side lengths of all rhombuses are proportional, but the angles can vary.

4.  $\angle CBD \cong \angle CAE$  by Corresponding Angles Theorem.  $\angle C \cong \angle C$  by the Reflexive Property. So  $\triangle CBD \cong \triangle CAE$  by AA.

5.  $\frac{6}{14} = \frac{20}{CE}$ ;  $CE = (20 \times 14) \div 6 \approx 46.7$  in.

6.  $(6, -4)$

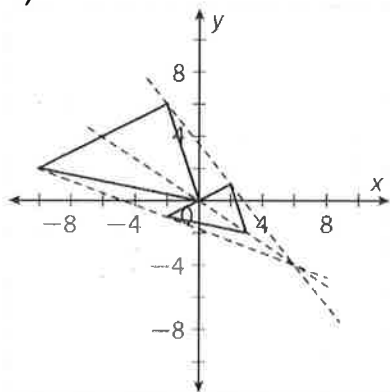

7.  $(-8, 7)$

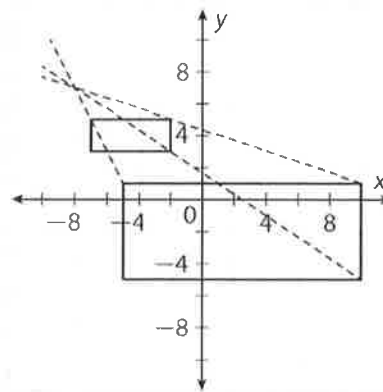

#### Practice and Problem Solving: C

1.  $\frac{CD}{FG} = \frac{DE}{GH}$ ;  $\frac{CD}{FG} = \frac{CE}{FH}$ ;  $\frac{DE}{GH} = \frac{CE}{FH}$ ;  
 $\frac{CD}{DE} = \frac{FG}{GH}$ ;  $\frac{CD}{CE} = \frac{FG}{FH}$ ;  $\frac{DE}{CE} = \frac{GH}{FH}$ ;  
 $m\angle C = m\angle F$ ;  $m\angle D = m\angle G$ ;  $m\angle E = m\angle H$

2. Possible answer:  $\frac{CD}{FG} = \frac{DE}{GH}$  and

$\frac{CD}{DE} = \frac{FG}{GH}$ ;  $w = CD$ ;  $x = FG$ ;  $y = DE$ ;

$z = GH$ . Substitute the letters into the first proportion:  $\frac{w}{x} = \frac{y}{z}$ . Cross multiply:

$wz = xy$ . Divide both sides by  $z$  and by  $y$ :  
 $\frac{w}{y} = \frac{x}{z}$ . Replace the letters with the side

lengths to get the second proportion.

3. 9

4. No.  $\frac{WX}{XY} \neq \frac{XZ}{YZ}$

5.  $\triangle ADB$ ;  $\triangle BDC$

6.  $\triangle ABC$  and  $\triangle ADB$ :  $\frac{2}{1}$

$\triangle ABC$  and  $\triangle BDC$ :  $\frac{2\sqrt{3}}{3}$

$\triangle BDC$  and  $\triangle ADB$ :  $\frac{\sqrt{3}}{1}$

7.  $6 + 2\sqrt{3}$

8.  $3 + \sqrt{3}$ ;  $3 + 3\sqrt{3}$

## Answer Key

- 1 Read the selection from the section "War Criminals."

*Under the terms of the Treaty, the Germans accepted responsibility for the war and agreed to pay financial reparations to the Allies. The amount owed was set at 132 billion gold Reichmarks, or 32 billion U.S. dollars.*

Which two words would BEST replace "responsibility" and "reparations" in the selection above?

- (A) **fault; penalties**
- (B) ownership; dues
- (C) guilt; incentives
- (D) authority; damages

- 2 Read the selection from the section "Death Sentence."

*He said that a debt this size made it impossible for Germany to rebuild herself. In other words, the Allied powers were asking a whole people to sign their own "death sentence."*

Why did the author use the phrase "death sentence"?

- (A) to explain why the Treaty was harsh but fair when compared to the damage caused during World War I
  - (B) to show that the Treaty helped certain countries while harming others
  - (C) to describe one way in which the Treaty would help Germany pay for the destruction it had caused
  - (D) **to indicate that the Treaty ensured Germany would never be a successful country again**
- 3 Which option accurately compares and contrasts how Image 1 and Image 5 affect the reader's understanding of the Treaty of Versailles?
- (A) Image 1 demonstrates the disagreements between members of the Big Four, while Image 5 shows united opposition from the people of Germany.
  - (B) Image 1 explains the optimism about the Treaty from the winning countries, while Image 5 shows similar excitement from the people of Germany.
  - (C) **Image 1 shows excitement about the Treaty in the victorious nations, while Image 5 highlights how Germany reacted to the Treaty.**
  - (D) Image 1 describes the uncertainty of the Treaty, while Image 5 captures the frustration present in the defeated countries.
- 4 Which conclusion is supported in both Image 3 and the article?
- (A) The Treaty of Versailles required every nation that fought in the war to give up some territory.
  - (B) **The Treaty of Versailles changed the borders of several nations across Europe.**
  - (C) The Treaty of Versailles was developed specifically to gain access to German territory.
  - (D) The Treaty of Versailles requested but did not require countries to surrender any of their pre-war lands.

## The Necklace (short story)-ANSWER KEY.

English	Name
Unit 4	The Necklace
<p>Questions</p> <p>1. What does irony mean and what are the three different types of irony?</p> <p>2. How can someone use verbal irony?</p> <p>3. What can be an example of situational irony?</p> <p>4. What does dramatic irony mean?</p> <p>5. What does tone mean?</p>	<p>Notetaking Column</p> <p>Irony The difference between what we expect or what seems suitable in relation to what actually happens and there are three different types of irony.</p> <p>Verbal Irony Occurs when someone says something but <i>means</i> the opposite.</p> <ul style="list-style-type: none"> <li>● Example</li> <li>● "Nice day," you say as you slog through flood water up to your waist.</li> </ul> <p>Situational Irony Refers to an event that is <i>contrary to</i>, or the opposite of what we expected.</p> <ul style="list-style-type: none"> <li>● Example</li> <li>● The winner of the wrestling match is the weakest team member.</li> </ul> <p>Dramatic Irony Takes place when we know what is going to happen to a character but the character does not know.</p> <ul style="list-style-type: none"> <li>● Example</li> <li>● We know, but the robbers do not know, that the hotel they plan to rob is hosting a police convention.</li> </ul> <p>Tone Writer/speaker's attitude towards the characters, subject, and or audience.</p>
Summary	<p>There are three different types of irony- verbal, dramatic, situational, and dramatic irony. Situational irony occurs when something unexpected happens, verbal irony is when you say something but mean the opposite, and lastly, dramatic irony is when we know what is going to happen but the characters do not know.</p>

## ***The Necklace* (short story)-ANSWER KEY**

PLOT STRUCTURE TEXT DIAGRAM ELEMENTS	POSSIBLE RESPONSES
<b>CHARACTERS</b>	
<b>Protagonist and Main Character(s)</b>	Mathilde Loisel and Mr. Loisel the protagonists; Madame Forestier
<b>Antagonist</b>	The glorified necklace and social status.
<b>SETTING</b>	
<b>Time</b>	Takes place over ten years.
<b>Place</b>	Paris at the Loisel's home and at an evening reception.
<b>CONFLICT</b>	Mathilde wants to attend a reception but has nothing to wear and her friend Forestier lends her a resplendent diamond necklace.
<b>TURNING POINT</b>	As a result, Mathilde's desire for an autocratic rather than middle-class life pays off at the reception because she is exquisite and everyone notices her, however, when she returns home, she discovers her necklace is no longer around her neck.
<b>RISING ACTION</b>	Loisel's destroyed their life by borrowing money and working nights for ten years to replace the material object.
<b>FALLING ACTION</b>	Forestier informs Mathilde the original necklace was costume jewelry and not worth anything.
<b>THEME</b>	Appearances are deceiving and the desire to be someone else often causes a person to lose the chance of being blissful in the present moment.